

19" Cable Manager, 40x40mm, metal, Mounting central, cable entry central

Product No.	26.30.0015
Manufacturer	ROLINE
Manufacturer No.	26.30.0015
EAN (single piece)	7630049624702

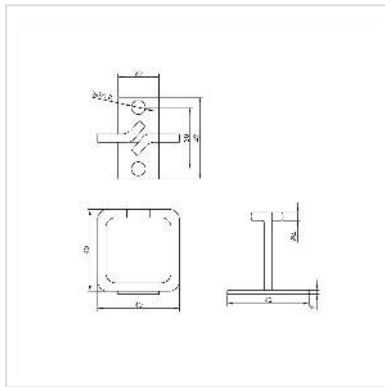

ROLINE 19" cable manager with curved opening for easy cable routing - the 140x100mm cable manager offers plenty of space for your cable harnesses and ensures tidy network technology in your server cabinet

- For mounting on 19" panel/slide mounts
- Helps with the clean cabling of your network technology
- Cable routing laterally in front of the 19" bracket
- Cable manager with 5mm metal thickness, galvanized; angle welded

Technical specifications

Manufacturer	ROLINE
Product group	19"-/10"-Cable management
Product type	Cable lug
Colour	silver
Scope of delivery	Cable Manager
Height	40 mm
Width	40 mm
Depth	42 mm
Weight	25.3 g

Height of packaging (single piece)	10 mm
---------------------------------------	-------

Width of packaging (single piece)	40 mm
--------------------------------------	-------

Depth of packaging (single piece)	40 mm
--------------------------------------	-------

Package weight (single piece)	0.02 kg
----------------------------------	---------